

# Data Sheet



Article number: 12516700050500  
Description: KLEE-coil 516 700 050.500  
M5 Stainless 14305

## Measures

---

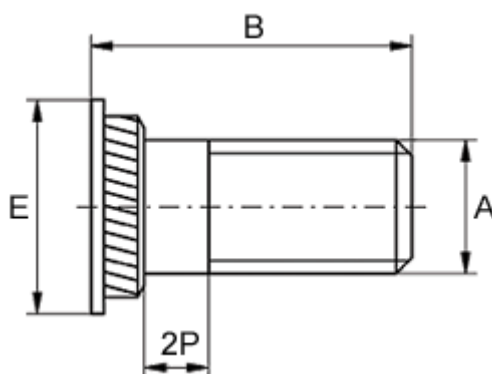

For plate thickness, min	= 1.5
Head diameter E	= 8
Hole diameter +0.1	= 6.4
Length B	= 16
Male thread A	= M5x0,8
Min distance to edge	= 3.3